

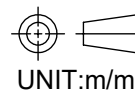

**PROPRIETARY AND CONFIDENTIAL**

THE INFORMATION CONTAINED IN THIS DRAWING IS THE SOLE PROPERTY OF UNICE E-O SERVICES INC. ANY REPRODUCTION IN PART OR AS A WHOLE WITHOUT THE WRITTEN PERMISSION OF UNICE E-O SERVICES INC IS PROHIBITED.

NO	Description
1	+24V
2	COM
3	+ Limit
4	- Limit
5	Home Limit
6	N/A
7	A
8	N/A
9	B
10	COM
11	/A
12	/B
13	N/A
14	N/A
15	N/A

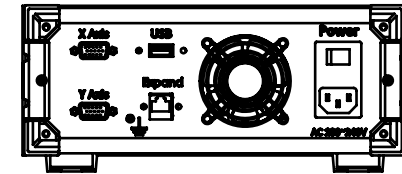
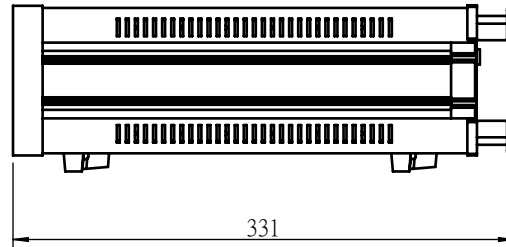
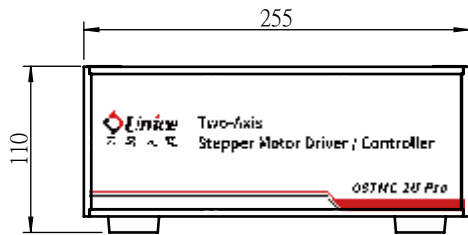
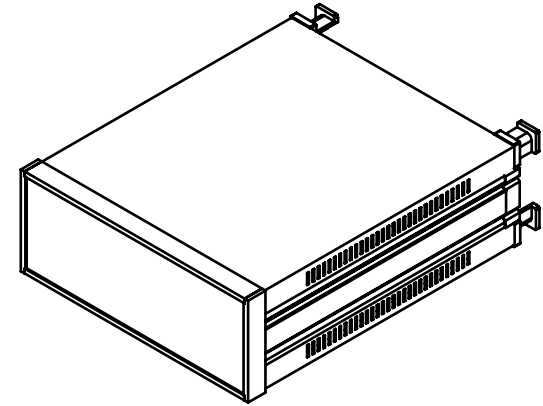
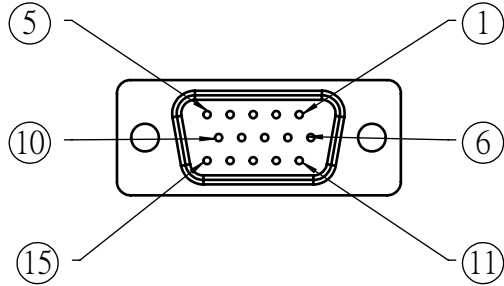

 <b>Unice E-O Services Inc.</b> No.5, Andong Rd., Chung Li District, Taoyuan City 32063, Taiwan, R.O.C.			TITLE:	
			08TMC-2U Pro	
			DWG. NO.	08TMC-2U Pro
			MATERIAL:	
DRAWN	John	2026/4/14	SCALE:	1:5
ENG APPR.	Johnny	2026/4/14	REV	0